

## AD8509/AD8511

### FEATURES

- Single-Supply Operation: 3.3 V to 5 V
- High Output Current: 300 mA
- Low Supply Current: 6 mA
- Stable with 1000 pF Loads
- Pin Compatible with LMC6009
- Pin Compatible with CL-FP6131

### APPLICATIONS

LCD Driver

### FUNCTIONAL BLOCK DIAGRAM

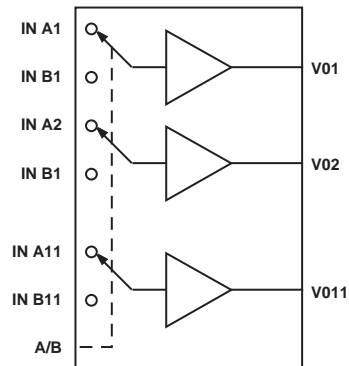

### PIN CONFIGURATIONS 48-Lead TSSOP (RU Suffix)

### GENERAL DESCRIPTION

The AD8509 is a 9-channel (AD8511 an 11-channel) LCD reference driver designed to drive 64 gray scale column drivers. Each buffer has an A/B input used to select between two voltages for LCD displays. These buffers are used to drive the resistor ladders of LCD column drivers for gamma correction.

These LCD drivers have higher slew rates and output drive current than similar competitive parts. This increases the stability of the reference ladder, resulting in better gray scale and visual performance.

The AD8509 and AD8511 are specified over the  $-20^{\circ}\text{C}$  to  $+85^{\circ}\text{C}$  temperature range. They are available in 48-lead thin shrink small outline (TSSOP) surface mount packages in tape and reel.

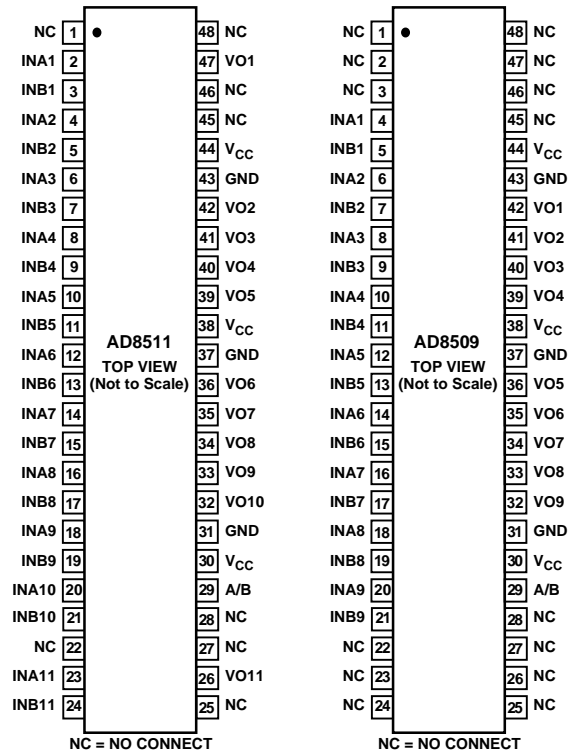

REV. 0

Information furnished by Analog Devices is believed to be accurate and reliable. However, no responsibility is assumed by Analog Devices for its use, nor for any infringements of patents or other rights of third parties which may result from its use. No license is granted by implication or otherwise under any patent or patent rights of Analog Devices.

# AD8509/AD8511—SPECIFICATIONS

## ELECTRICAL CHARACTERISTICS ( $V_S = +5\text{ V}$ , $T_A = +25^\circ\text{C}$ , unless otherwise noted)

Parameter	Symbol	Conditions	Min	Typ	Max	Units
<b>INPUT CHARACTERISTICS</b>						
Offset Voltage	$V_{OS}$				20	mV
Input Bias Current	$I_B$				50	nA
Voltage Gain	$A_{VO}$		0.985			V/V
<b>OUTPUT CHARACTERISTICS</b>						
Output Voltage High	$V_{OH}$	$I_{LOAD} = +20\text{ mA}$	4.8			V
Output Voltage Low	$V_{OL}$	$I_{LOAD} = -20\text{ mA}$			200	mV
Output Short Circuit Current	$I_{SC}$		120	350		mA
<b>POWER SUPPLY</b>						
Load Regulation		$V_{IN} = 0.5\text{ V} - 4.5\text{ V}$ , $I_{SOURCE} = 20\text{ mA}$		7		mV
Load Regulation		$V_{IN} = 0.5\text{ V} - 4.5\text{ V}$ , $I_{SINK} = 20\text{ mA}$		7		mV
Supply Current	LCD09	$I_{SY}$ , $V_{IN} = 2.5\text{ V}$			8.5	mA
Supply Current	LCD11	$I_{SY}$ , $V_{IN} = 2.5\text{ V}$			10	mA
<b>DYNAMIC PERFORMANCE</b>						
Slew Rate		$C_L = 15\text{ pF}$		7		V/ $\mu\text{s}$
Slew Rate		$R_L = 250\ \Omega$		6.2		V/ $\mu\text{s}$
Settling Time	$t_s$	$IDC = 13\text{ mA}$ (Sink/Source)		3	6	$\mu\text{s}$
<b>LOGIC INPUT CHARACTERISTICS</b>						
Input Current Low	$I_{IL}$				1.0	$\mu\text{A}$
Input Current High	$I_{IH}$				1.5	$\mu\text{A}$
Input Voltage Low	$V_{IL}$				0.8	V
Input Voltage High	$V_{IH}$		2.0			V

Specifications subject to change without notice.

### ABSOLUTE MAXIMUM RATINGS\*

Supply Voltage	+7 V
Input Voltage	GND to $V_S$
Storage Temperature Range	
RU Package	$-65^\circ\text{C}$ to $+150^\circ\text{C}$
Operating Temperature Range	
AD8509A/AD8511A	$-20^\circ\text{C}$ to $+85^\circ\text{C}$
Junction Temperature Range	
RU Package	$-65^\circ\text{C}$ to $+150^\circ\text{C}$
Lead Temperature Range (Soldering, 60 sec)	$+300^\circ\text{C}$

\*Stresses above those listed under Absolute Maximum Ratings may cause permanent damage to the device. This is a stress rating only; the functional operation of the device at these or any other conditions above those indicated in the operational sections of this specification is not implied. Exposure to absolute maximum rating conditions for extended periods may affect device reliability.

Package Type	$\theta_{JA}$ *	$\theta_{JC}$	Units
48-Lead TSSOP (RU)	115	42	$^\circ\text{C/W}$

#### NOTE

\* $\theta_{JA}$  is specified for the worst case conditions, i.e.,  $\theta_{JA}$  specified for device soldered in circuit board for surface mount packages.

### CAUTION

ESD (electrostatic discharge) sensitive device. Electrostatic charges as high as 4000 V readily accumulate on the human body and test equipment and can discharge without detection. Although the AD8509/AD8511 features proprietary ESD protection circuitry, permanent damage may occur on devices subjected to high energy electrostatic discharges. Therefore, proper ESD precautions are recommended to avoid performance degradation or loss of functionality.

### ORDERING GUIDE

Model	Temperature Range	Package Description	Package Options
AD8509ARU*	$-20^\circ\text{C}$ to $+85^\circ\text{C}$	48-Lead TSSOP	RU-48
AD8511ARU*	$-20^\circ\text{C}$ to $+85^\circ\text{C}$	48-Lead TSSOP	RU-48

\* Available in 2,000 piece reels only.

Table I. MUX Function

A/B Select (Pin 29)	Input
Logic HI	INAx
Logic LOW	INBx



# Typical Performance Characteristics—AD8509/AD8511

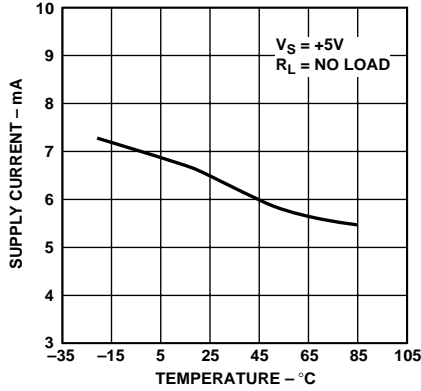

Figure 1. Supply Current vs. Temperature

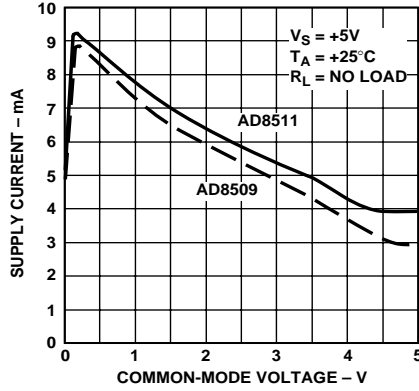

Figure 2. Supply Current vs. Common-Mode Voltage

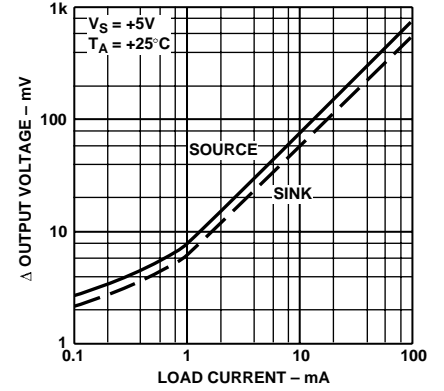

Figure 3. Output Voltage to Supply Rail vs. Load Current

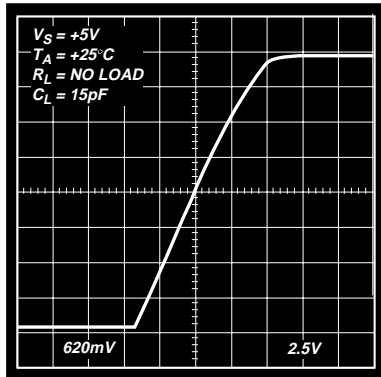

Figure 4. Large Signal Transient Response – Rising

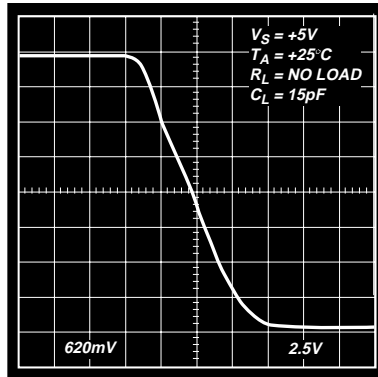

Figure 5. Large Signal Transient Response – Falling

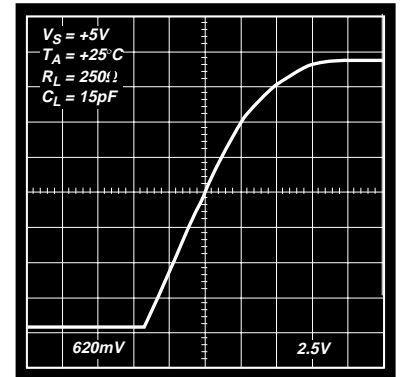

Figure 6. Large Signal Transient Response – Rising

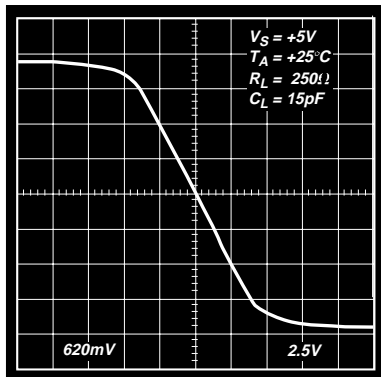

Figure 7. Large Signal Transient Response – Falling

# AD8509/AD8511

## APPLICATIONS

The AD8509 and AD8511 are CMOS buffers with A/B inputs, which are used to select between two different reference voltages set up by an external resistor ladder. Input bias currents are orders of magnitude less than competitive parts, allowing very large resistor ladders to be used to save supply current. A guaranteed value of 50 nA is much higher than actual values and is limited by leakage in the test system.

Buffer outputs are designed to drive resistive loads. They are also stable with capacitive loads, so no resistors should be used in series with these outputs to attain the best display performance. Outputs have high slew rates and 6  $\mu$ s settling times. Each output is capable of delivering a minimum of 120 mA, assuring fast response to varying loads.

The AD8509 is a 9-channel buffer and is similar to the LMC6009 in functionality. The AD8511 is an 11-channel buffer similar to the CL-FP6131. However, the control to select either 9- or 11-channel operation, the EN\_11 pin of the CL-FP6131, is not available on the AD8511. If 9-channel operation is desired, use the AD8509.

Power supply pins on the AD8509 and AD8511 have multiple ground and  $V_{CC}$  connections. Because of the high peak currents that these buffers can deliver, it is strongly recommended that all be connected, and that the  $V_{CC}$  pins be suitably bypassed.

C3237-8-10/97

## OUTLINE DIMENSIONS

Dimensions shown in inches and (mm).

### 48-Lead TSSOP (RU Suffix)

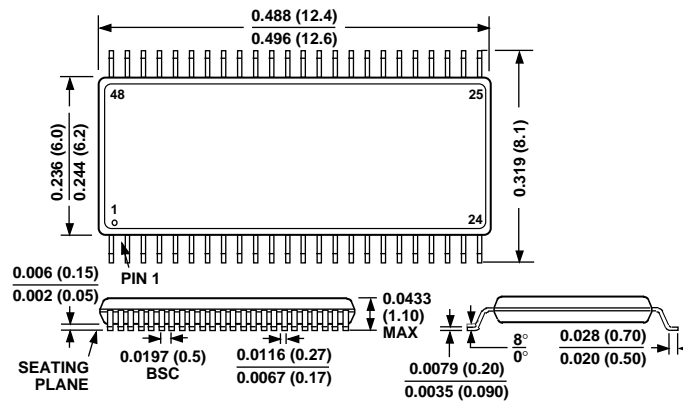

PRINTED IN U.S.A.